



METER

ATMOS 41



TABLE OF CONTENTS

1. Introduction.....	1
2. Operation	3
2.1 Installation	3
2.2 Connecting the ATMOS 41	5
2.2.1 Safety Precautions	5
2.2.2 Cable Problems.....	5
2.3 Connecting to a ZENTRA or EM60 Family Data Logger	6
2.4 Connecting to a Non-METER Logger	6
2.5 Pigtail End Wiring.....	6
2.6 Communication	7
3. System.....	9
3.1 Specifications.....	9
3.2 Pyranometer	12
3.3 Anemometer	13
3.4 Vapor Pressure Sensor.....	14
3.5 Rain Gauge.....	15
3.6 Temperature Sensor.....	16
3.7 Lightning Sensor.....	17
3.8 Compass	17
3.9 Configuring the Compass and Lightning Sensor Using ProCheck.....	18
3.9.1 Compass Configuration.....	18
3.9.2 Lightning Strike Reject Level Configuration.....	18
3.10 Barometric Sensor	19
3.11 Tilt Sensor.....	19

3.12 Theory	19
3.12.1 Wind Speed and Direction	19
3.12.2 Temperature Sensor	21
3.13 Limitations.....	23
3.13.1 Snow and Ice Accumulation	23
3.13.2 Heavy Rain and Strong Wind	23
4. Service.....	25
4.1 Calibration	25
4.2 Cleaning and Maintenance.....	25
4.3 Troubleshooting.....	27
4.4 Customer Support.....	29
4.5 Terms and Conditions	30
References	33
Index	35

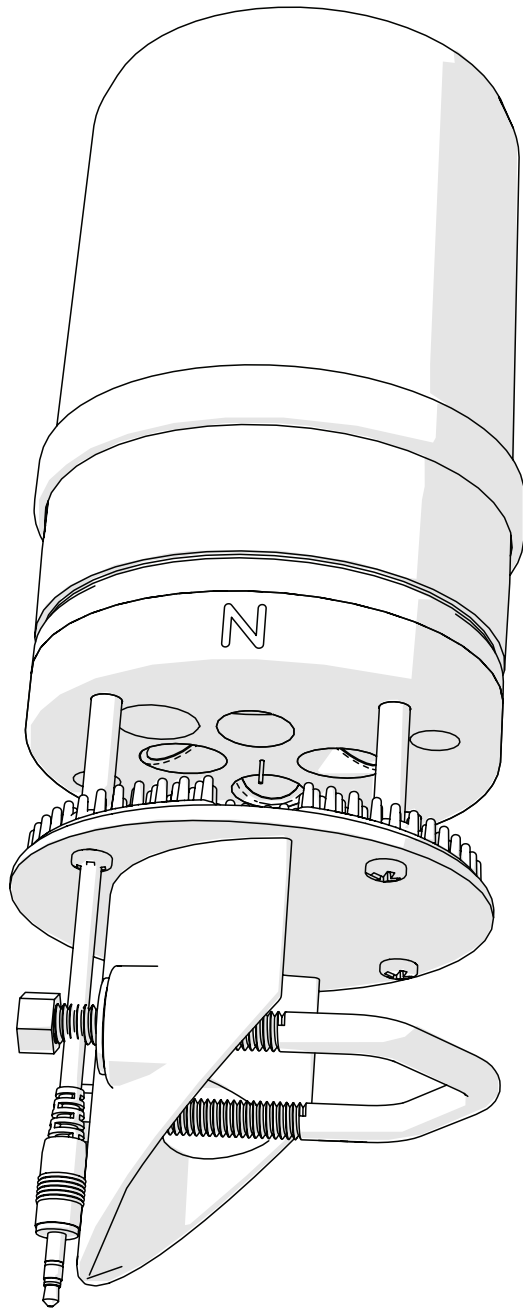

1. INTRODUCTION

Thank you for choosing the ATMOS 41 Compact Weather Station from METER Group, Inc.

The ATMOS 41 Compact Weather Station is designed for continuous monitoring of environmental variables, including all standard weather measurements (see [Measurement Specifications on page 9](#)). The ATMOS 41 measures the following:

- solar radiation
- precipitation
- precipitation max intensity
- air temperature
- barometric pressure
- vapor pressure
- relative humidity
- wind speed
- wind direction
- maximum wind gust
- lightning strikes
- lightning distance
- tilt
- compass orientation

WEATHER STATIONS REIMAGINED

All sensors are integrated into a single, small form-factor unit, requiring minimal installation effort. A robust, no moving parts design that prevents errors because of wear or fouling make the weather station ideal for long term, remote installations.

Applications of the ATMOS 41 are listed below:

- weather monitoring
- microenvironment monitoring
- spatially-distributed environmental monitoring
- crop weather monitoring
- fire danger monitoring/mapping
- weather networks

Additional advantages include its low-power design that supports battery-operated data loggers, and the SDI-12 three-wire interface. A tilt sensor warns the user of out-of-level condition, and no configurations are necessary.

2. OPERATION

Please read all instructions before operating the ATMOS 41 to ensure it performs to its full potential.

2.1 INSTALLATION

Follow the steps listed in [Table 1](#) to set up the ATMOS 41 and start collecting data.

Table 1 Installation

Tools Needed	<p>Wrench 13 mm (1/2 inch)</p> <p>Secure mounting location</p> <p>Mount (if using ATMOS 41 compass-corrected wind direction, mount on nonferrous pipe)</p> <ul style="list-style-type: none">• meteorological stand• pole in cement• tripod <p>Diameter: 31.8 to 50.8 mm, 1.25 to 2.0 inch</p> <p>NOTE: Smaller mounts are compatible if washers are added to the V-bolt (not included). Standard pipe sizes that are compatible are 1.0-, 1.25-, and 1.5-in diameter pipes. Square tubing with a width of 1.25 to 2.0 in or T-posts can also work as mounting options.</p>
Preparation	<p>Consider the Surroundings Avoid obstructions. Ensure that site selection is far from wind obstruction. Make sure surrounding objects will not shade the solar radiation sensor.</p> <p>Conduct System Check Verify all sensors read within expected ranges (see Section 3 on page 9).</p> <p>Adjust Pole Height Many installations require the ATMOS 41 to be mounted 2 m above ground, but this can be adjusted based on the specific application.</p>

Table 1 Installation (*continued*)

Mounting	<p>Install on Mounting Pole The ATMOS 41 is fitted with a V-bolt, allowing it to be mounted on top of most posts, poles, tripods, etc.</p> <p>Mount Toward True North If mounting the ATMOS 41 on a ferrous metal post or the compass-corrected wind direction is OFF, the ATMOS 41 must be oriented correctly for accurate wind direction measurements. An N engraved on the side of the instrument should be oriented to point true north (not magnetic north). NOTE: All ATMOS 41 units are shipped with the compass-corrected wind direction set to OFF.</p> <p>If mounting on a plastic post, the compass-corrected wind direction can be turned ON (uses an internal compass; can be turned ON using a ProCheck (see Section 3.9 on page 18 or SDI-12 command; see the ATMOS 41 Integrator's Guide).</p> <p>Level the System Use the bubble level underneath the ATMOS 41 or a ProCheck display to level the weather station. The angle of the mounting pole may need to be adjusted or shims added to the ATMOS 41 pole interface to achieve level. The ATMOS 41 must be within approximately ± 2 degrees of dead level in both the X and Y directions to accurately measure rainfall and solar radiation.</p> <p>Secure the System Use a wrench to tighten the bolts, securing the ATMOS 41 flat and tight against the top of the stand.</p>	
	Connecting	<p>Plug Sensor into Data Acquisition System</p> <ul style="list-style-type: none"> • Connect the 3.5 mm plug into a ZENTRA or EM60 family of data loggers. • Configure it to read the ATMOS 41 (refer to Section 3 on page 9). <p>Verify</p> <ul style="list-style-type: none"> • Use the SCAN function in the software to show a list of ATMOS 41 readings. • Verify that these readings are within expected ranges. <p>Third Party Data Loggers To connect to a non-METER data logger, see the ATMOS 41 Integrator's Guide.</p>

NOTE: ATMOS 41 will not work with legacy Decagon data loggers (EM50 Series and EM5B) because the ATMOS 41 outputs contain too many parameters.

2.2 CONNECTING THE ATMOS 41

The ATMOS 41 Compact Weather Station works most efficiently with a ZENTRA or EM60 data loggers. This system will not work with legacy data loggers (Decagon EM5, EM5B, EM50, EM50R, EM50G) because the ATMOS 41 has too many output parameters (previously limited to three). The standard station with a 3.5 mm stereo connector (Figure 1) connects to and is configured with a ZENTRA or EM60 data logger.



Figure 1 3.5 mm stereo plug wiring

The ATMOS 41 is also compatible with third party loggers and may be purchased with stripped and tinned wires (pigtail) for terminal connections. For extensive directions on how to integrate the weather station into third-party loggers, visit <https://www.metergroup.com/environment/products/atmos-41-weather-station/#support> to reference the *ATMOS 41 Integrator's Guide*.

The ATMOS 41 comes standard with a 5-m cable. It may be purchased with custom cable lengths for an additional fee (on a per-meter fee basis). METER has successfully tested digital communication on cable lengths up to 1,000 m (3,200 ft). This option eliminates the need for splicing the cable (a possible failure point). However, the maximum recommended length is 75 m.

2.2.1 SAFETY PRECAUTIONS

METER sensors are built to the highest standards, but misuse, improper protection, or improper installation may damage the sensor and possibly void the manufacturer's warranty. Before integrating ATMOS 41 or other METER sensors into a system, make sure to follow the recommended installation instructions and have the proper protections in place to safeguard sensors from damage.

2.2.2 CABLE PROBLEMS

Improperly protected cables can lead to severed cables or disconnected sensors. Cabling issues can be caused by many factors, including rodent damage, driving over sensor cables, tripping over the cable, not leaving enough cable slack during installation, or poor sensor wiring connections. To relieve strain on the connections and prevent loose cabling from being inadvertently snagged, gather and secure the cable travelling between the ATMOS 41 and the data acquisition device to the mounting mast in one or more places. Install cables in conduit or plastic cladding when near the ground to avoid rodent damage. Tie excess cable to the data logger mast to ensure cable weight does not cause sensor to unplug.

2.3 CONNECTING TO A ZENTRA OR EM60 FAMILY DATA LOGGER

The ATMOS 41 works seamlessly with ZENTRA or EM60 data loggers. Plug the 3.5 mm stereo plug connector into one of the six sensor ports.

Once the ATMOS 41 has been connected to a ZENTRA or EM60 data logger, configure the logger port for the ATMOS 41, and set the measurement interval. Logger configuration may be done using either ZENTRA Utility (desktop and mobile) or ZENTRA Cloud (for cell-enabled ZENTRA data loggers).

To download ATMOS 41 data from a ZENTRA or EM60 logger, use ZENTRA Utility or ZENTRA Cloud.

NOTE: The ATMOS 41 draws more current than most other METER sensors because it makes frequent measurements of wind speed and precipitation. As a result, plugging multiple ATMOS 41 stations into a single ZENTRA or EM60 data loggers may have significant impact on battery life. At times or in regions with plentiful sunshine, the solar panel should provide ample charge and this should not be an issue. But, during the winter or periods of extended heavy clouds, the solar panel may not provide enough charging current to keep the system running with multiple ATMOS 41 units. METER recommends using only one ATMOS 41 per ZENTRA or EM60 data logger.

2.4 CONNECTING TO A NON-METER LOGGER

The ATMOS 41 weather station may be purchased for use with non-METER data loggers. These sensors typically come configured with stripped and tinned (pigtail) lead wires for use with screw terminals. Refer to the third-party logger manual for details on wiring. The *ATMOS 41 Integrator's Guide* gives detailed instructions on connecting the weather station to non-METER loggers. Visit <https://www.metergroup.com/environment/products/atmos-41-weather-station/#support> to reference the *ATMOS 41 Integrator's Guide*.

2.5 PIGTAIL END WIRING

Connect the weather station wires to the data logger as illustrated in Figure 2, with the power supply wire (Brown) connected to the excitation, the digital out wire (Orange) to a digital input, and the bare ground wire to ground.

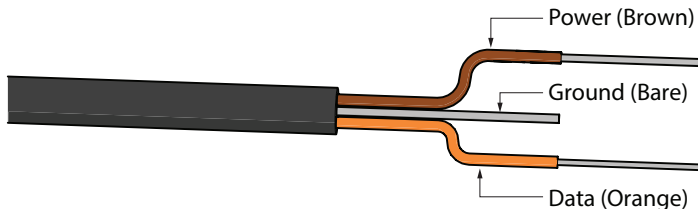

Figure 2 Pigtail wiring

NOTE: Some early ATMOS 41 units may have the older Decagon wiring scheme where the power supply is white, the digital out is red, and the bare wire is ground.

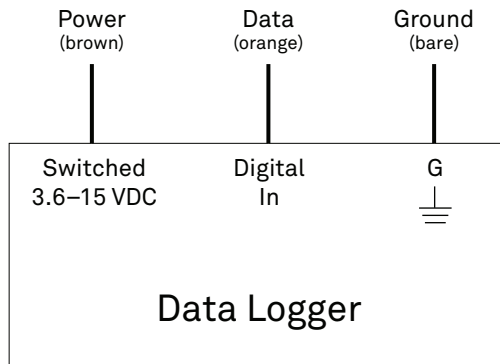

Figure 3 Wiring diagram

NOTE: The acceptable range of excitation voltages is from 3.6 to 15 VDC. To read the ATMOS 41 with Campbell Scientific data loggers, power the sensors off a 12 V port or switched 12 V port.

If the ATMOS 41 has a standard 3.5-mm plug and will be connected to a non-METER data logger, please use one of the following two options when connecting to a non-METER data logger.

Option 1

1. Clip off the plug on the sensor cable.
2. Strip and tin the wires.
3. Wire it directly into the data logger.

This option has the advantage of creating a direct connection with no chance of the sensor becoming unplugged. However, it then cannot be easily used in the future with a METER readout unit or data logger.

Option 2

Obtain an adapter cable from METER.

The adapter cable has a connector for the stereo jack on one end and three wires (or pigtail adapter) on the other end for connection to a data logger. Both the stripped and tinned adapter cable wires have the same termination as in [Figure 3](#); the brown wire is excitation, the orange is output, and the bare wire is ground.

2.6 COMMUNICATION

The ATMOS 41 weather station communicates using the SDI-12 communication protocol. To obtain detailed instructions, refer to the [ATMOS 41 Integrator's Guide](#).

3. SYSTEM

This section describes the compact weather station system.

3.1 SPECIFICATIONS

MEASUREMENT SPECIFICATIONS

Solar Radiation	
Range:	0 to 1750 W/m ²
Resolution:	1 W/m ²
Accuracy:	±5% of measurement typical

Precipitation	
Range:	0 to 125 mm/h
Resolution:	0.017 mm
Accuracy:	±5% of measurement from 0 to 50 mm/h

Vapor Pressure	
Range:	0 to 47 kPa
Resolution:	0.01 kPa
Accuracy:	Varies with temperature and humidity, ±0.2 kPa typical below 40 °C

Relative Humidity	
Range:	0 to 100%
Resolution:	0.1%
Accuracy:	Varies with temperature and humidity, ±3% RH typical

Air Temperature	
Range:	-40 to 50 °C
Resolution:	0.1 °C
Accuracy:	±0.6 °C

Humidity Sensor Temperature	
Range:	-40 to 50 °C
Resolution:	0.1 °C
Accuracy:	±1.0 °C

SYSTEM

Barometric Pressure

Range: 50 to 110 kPa

Resolution: 0.01 kPa

Accuracy: ± 0.1 kPa

Horizontal Wind Speed

Range: 0 to 40 m/s

Resolution: 0.01 m/s

Accuracy: The greater of 0.3 m/s or 3% of measurement

Wind Gust

Range: 0 to 40 m/s

Resolution: 0.01 m/s

Accuracy: The greater of 0.3 m/s or 3% of measurement

Wind Direction

Range: 0 to 359°

Resolution: 1°

Accuracy: $\pm 5^\circ$

Compass Heading

Range: 0 to 359°

Resolution: 1°

Accuracy: $\pm 5^\circ$

Tilt

Range: 0 to 180°

Resolution: 0.1°

Accuracy: $\pm 1^\circ$

Lightning Strike Count

Range: 0 to 65,535 strikes

Resolution: 1 strike

Accuracy: Variable with distance, >25% detection at <10 km typical

Lightning Average Distance

Range:	0 to 40 km
--------	------------

Resolution:	3 km
-------------	------

Accuracy:	Variable
-----------	----------

Dimensions

10 cm diameter x 34 cm height (includes rain gauge filter)

Cable Length

5 m (custom cable lengths are available for an additional cost)

Electrical and Timing Characteristics**Supply Voltage (VCC) to GND**

Minimum	3.6 V
---------	-------

Typical	
---------	--

Maximum	15.0 V
---------	--------

Digital Input Voltage (logic high)

Minimum	2.8 V
---------	-------

Typical	3.0 V
---------	-------

Maximum	15.0 V
---------	--------

Digital Input Voltage (logic low)

Minimum	-0.3 V
---------	--------

Typical	0.0 V
---------	-------

Maximum	0.8 V
---------	-------

Power Line Slew Rate

Minimum	1.0 V/ms
---------	----------

Typical	
---------	--

Maximum	
---------	--

Current Drain (during measurement)

Minimum	0.2 mA
---------	--------

Typical	8.0 mA
---------	--------

Maximum	16.0 mA
---------	---------

Current Drain (while asleep)

Minimum	0.2 mA
Typical	0.3 mA
Maximum	0.4 mA

Operating Temperature Range

Minimum	-40 °C
Typical	
Maximum	50 °C

Power Up Time (SDI Ready)—aRx! Commands

Minimum	
Typical	10 s
Maximum	

Power Up Time (SDI Ready)—Other Commands

Minimum	
Typical	800 ms
Maximum	

Measurement Duration

Minimum	
Typical	110 ms
Maximum	3000 ms

Compliance

Manufactured under ISO 9001:2015
EM ISO/IEC 17050:2010 (CE Mark)

3.2 PYRANOMETER

Solar radiation is measured by a pyranometer that is integrated into the lip of the rain gauge funnel at the top of the ATMOS 41. Designed, manufactured, and calibrated by experts at Apogee Instruments, the miniature pyranometer uses a silicon-cell sensor to measure the total incoming (direct and diffuse) solar radiation. A carefully developed cosine-correcting head ensures accurate readings regardless of sun angle, while the painstakingly researched optical filter material balances cost and performance to ensure the silicon-cell provides

good accuracy regardless of temperature or sensor age. Silicon-cell sensors have excellent response time to changing radiation conditions and acceptable sensitivity across the solar spectrum, which make them perfect for use on the ATMOS 41.

Leveling the ATMOS 41 is particularly important for accurate solar radiation measurements. Out of level, the pyranometer will overestimate some portions of the day while underestimating others. Ensure accurate solar radiation measurements by carefully leveling the ATMOS 41 at installation. Bird droppings and other soiling of the domed sensor surface will cause serious errors in pyranometer measurements. Regularly check the sensor to make sure it is clean and check data often to identify possible problems. Isopropyl (rubbing) alcohol and a Q-tip work well for cleaning the sensor area. Do NOT use an abrasive cloth on the sensor surface, as it will scratch. Microfiber bags work well too.

The pyranometer is factory calibrated and the sensor-specific calibration value can be found on the interior of the rain funnel. This factor has already been added into the ATMOS 41 so there is no need to do anything with it. But, in the event that this value is needed, it can be found by taking the funnel off the base and checking underneath.

3.3 ANEMOMETER

The space underneath the rain gauge is where the ATMOS 41 measures wind speed. Ultrasonic signals emitted from transducers at right angles to each other bounce off the porous sintered glass plate (Figure 4) and back up to the opposite sensor. The speed of sound is affected by the wind, and the wind speed is calculated by measuring differences in the time it takes for sound to travel back and forth between sensors (see Section 3.12.1 on page 19).

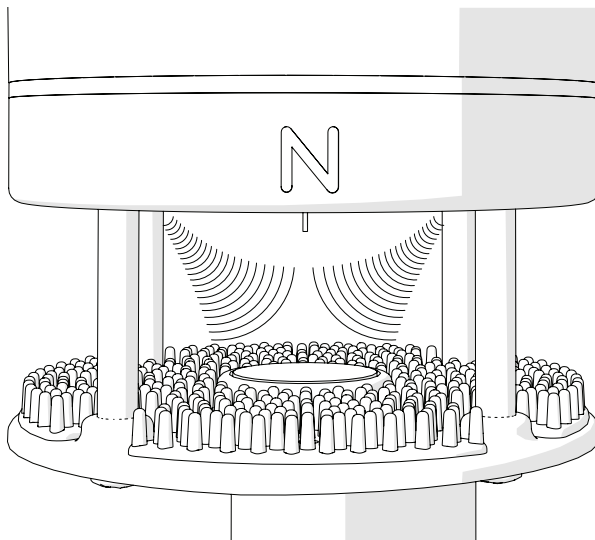

Figure 4 Anemometer

3.4 VAPOR PRESSURE SENSOR

The vapor pressure sensor (Figure 5) on the ATMOS 41 is located behind the circular Teflon™ membrane in the same housing as the sonic transducers. The Teflon protects the sensor from liquid water and dust while allowing water vapor to freely pass to the sensor and equilibrate with air vapor pressure. The sensor measures relative humidity and temperature and computes vapor pressure as the saturation vapor pressure at sensor temperature multiplied by the relative humidity.

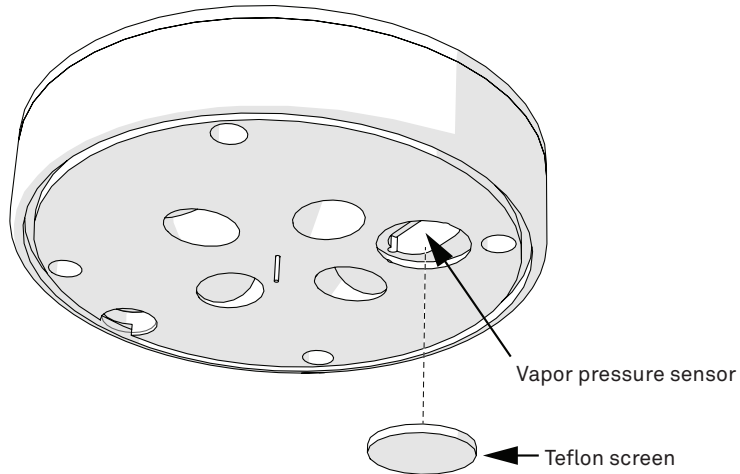

Figure 5 Vapor Pressure Sensor

If the relative humidity of the air is desired, it can be computed using Equation 1.

$$RH_{r,air} = \frac{e_a}{e_s(T_{air})} \quad \text{Equation 1}$$

where e_a is the vapor pressure of the air, from the ATMOS 41, and $e_s(T_{air})$ is saturation vapor pressure at the air temperature given by the ATMOS 41.

The saturation vapor pressure is calculated using the Magnus-Tetens equation (Equation 2) with the following coefficients described by Buck (1981).

$$e_s T_{air} = a \exp\left(\frac{b T_{air}}{c + T_{air}}\right) \quad \text{Equation 2}$$

Water	$a = 0.611 \text{ kPa}$	$b = 17.502$	$c = 240.97 \text{ }^\circ\text{C}$	$T_{air} = \text{NA}$
Ice	$a = \text{NA}$	$b = 21.87$	$c = 265.5 \text{ }^\circ\text{C}$	$T_{air} = \text{Temperature in } ^\circ\text{C}$

Unlike relative humidity, vapor pressure does not depend on temperature, and is generally conservative over time and space. The vapor pressure of the atmosphere near the relative humidity sensor is the same as the vapor pressure at the relative humidity sensor, even if the relative humidity sensor is not at the same temperature as the atmosphere. Additionally, it is the vapor pressure of the atmosphere (not RH) that controls the rate of vapor phase water transport (e.g., evaporation, transpiration, and distribution of water vapor). Therefore, vapor pressure is a much more useful measure of atmospheric moisture than relative humidity.

3.5 RAIN GAUGE

The ATMOS 41 contains a 9.31 cm diameter rain gauge. During rain events, the flared hole (Figure 6) forms the rain into drops that pass by the drip counter. The spring (Figure 6) acts as a filter to keep out large particles but still allows enough flow so water does not back up. Gold pins (Figure 6) measure each drop of rain. Because the flared hole forms a drop of a known size, the ATMOS 41 counts the drops and calculate the water volume. As the rain intensity increases, the drops become smaller, but the ATMOS 41 firmware contains an algorithm to automatically compensate for drop size as the rain increases.

IMPORTANT: The ATMOS 41 must be within approximately ± 2 degrees of dead level in both the X and Y directions to accurately measure rainfall. If not within this range, drops from the flared hole can miss the gold electrodes entirely.

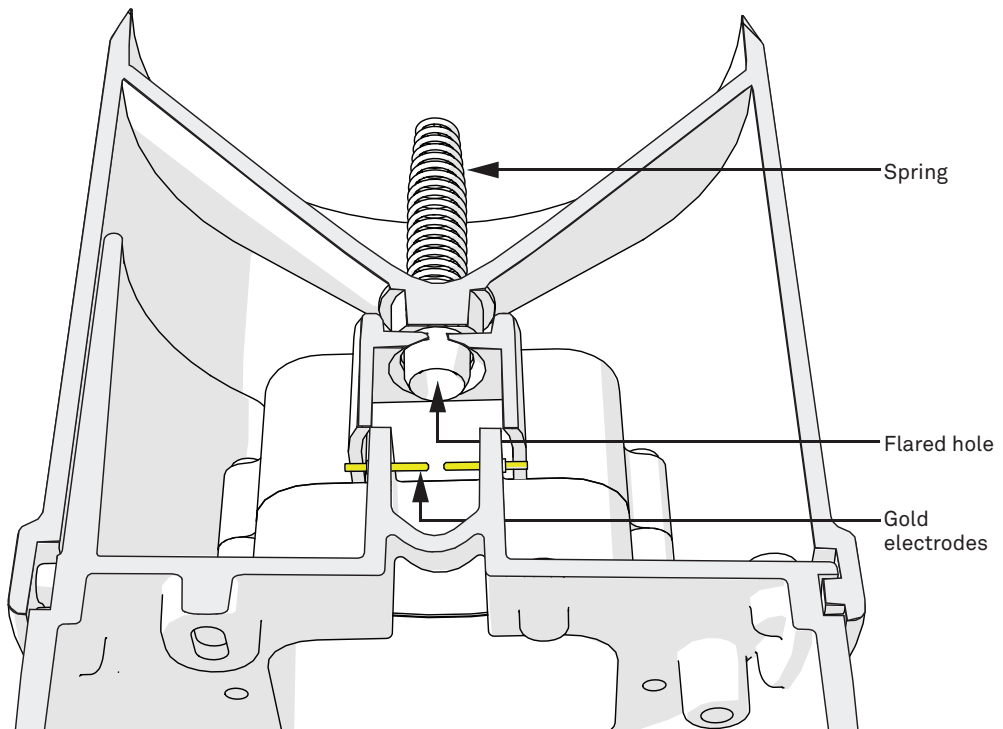

Figure 6 Rain gauge

SYSTEM

The rain gauge locks in place using two pegs on the side of the rain gauge funnel. Follow the steps below to get inside the rain gauge.

1. Press down against the spring and turn counter clockwise slightly.

Look for the graphic on the side of the rain gauge.

ATTENTION: BE CAREFUL TO UNPLUG THE PYRANOMETER CONNECTOR INSIDE THE FUNNEL BEFORE FULLY REMOVING THE FUNNEL.

2. Before replacing the cover, be sure to reattach the pyranometer connector as follows:
 - a. Insert the white female connector into the black male plug (check plug direction).
 - b. Check to be sure the downspout screen is in place on the water exit.

This keeps bugs out of the interior of the sensor.

3.6 TEMPERATURE SENSOR

The ATMOS 41 temperature measurement ([Figure 7](#)) is in the center of the anemometer area where a small stainless steel needle containing a tiny temperature sensor (thermistor) extends from the middle of the four sonic transducers. Unlike most air temperature measurements, the weather station sensor is not covered with louvered plates to protect from solar heating. Instead, it sits in open air, susceptible to solar heating of the instrument body. However, the ATMOS 41 calculates the air temperature accurately because solar radiation and the wind speed are known. These are the two main parameters that determine the error between measured air temperature and the actual air temperature. Therefore, it is possible to solve the energy balance to get what the actual temperature should be based on the solar load of the body and the convective cooling of that temperature sensor.

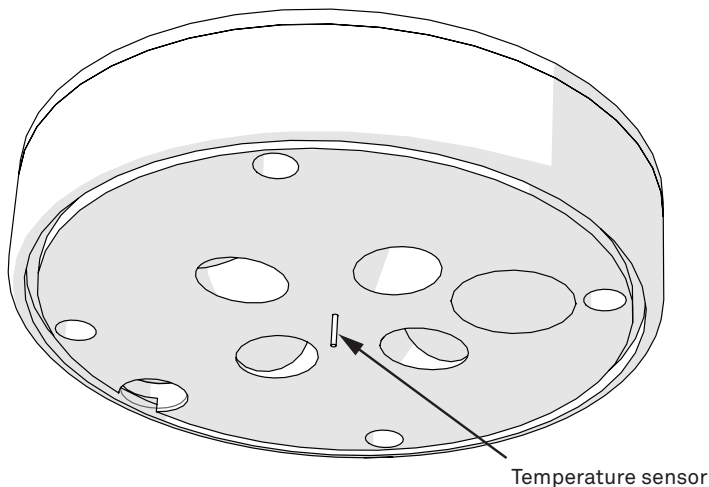

Figure 7 Temperature sensor

3.7 LIGHTNING SENSOR

The lightning sensor acts much like an AM radio. During a thunderstorm, the crack of the lightning disrupts the AM signal. The integrated circuit inside the sensor listens for this crackle, and when the sensor detects a disturbance, it registers the time of and distance (intensity of signal) to the strike. The sensor outputs the total number of strikes and average distance to these strikes in the measurement period. The sensitivity of the lightning sensor can be adjusted using the ProCheck (see [Section 3.9 on page 18](#)).

3.8 COMPASS

The ATMOS 41 has an internal digital compass that is used primarily as a diagnostic tool to determine if the ATMOS 41 has been inadvertently rotated after installation. It can also be used to correct the wind direction measurement, but only if the ATMOS 41 is mounted on a nonferrous mounting pole, as ferrous metal interferes with the digital compass accuracy.

All ATMOS 41 units are shipped with the compass-corrected wind direction turned **OFF**, so the typical installation requires that the **N** on the side of the weather station be oriented to north (true north, not magnetic north) for accurate wind direction measurements.

If the ATMOS 41 is mounted on a nonferrous pole, the wind direction compass correction can be turned **ON** (see [Section 3.9 on page 18](#)) and the ATMOS 41 does not need to be oriented towards north for accurate wind direction measurements.

NOTE: The compass-corrected wind direction will orient to magnetic north, so a correction will have to be applied to account for magnetic declination.

Even if the compass correction is turned **OFF**, the compass orientation will still be included in ATMOS 41 output, even if a ferrous metal post is affecting the accuracy of the measurement. These orientation data are still useful as a diagnostic tool to identify unintended rotation of the ATMOS 41, which would affect the accuracy of the wind direction measurement.

3.9 CONFIGURING THE COMPASS AND LIGHTNING SENSOR USING PROCHECK

A ProCheck can be used to configure the ATMOS 41 compass and lightning sensor for optimal performance. To make these modifications, the weather station must be plugged into the ProCheck via the stereo port.

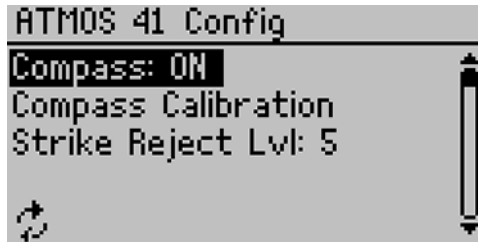

Figure 8 ATMOS 41 configuration screen

3.9.1 COMPASS CONFIGURATION

When the compass is set to **ON**, the onboard compass automatically corrects wind direction. If the compass is set to **OFF**, the wind direction is relative to the **N** (North) indicator on the side of the weather station. Since the compass is extremely sensitive to magnetic fields, it may be desirable to recalibrate the compass or even turn the compass correction **OFF** depending on the installation location and mounting.

Follow the steps below to turn the compass correction **ON** or **OFF**.

1. Highlight the compass setting
2. Press **Enter** to toggle the setting

Follow the steps below to perform a compass calibration.

1. Turn the compass correction to **ON**.
2. Highlight the compass calibration option
3. Press **Enter** to begin the calibration.
4. Follow the directions on the ProCheck screen.

3.9.2 LIGHTNING STRIKE REJECT LEVEL CONFIGURATION

The Strike Reject Lvl adjusts the lightning sensor threshold used to differentiate between man-made electrical noise and lightning strikes. The higher the value, the less likely man-made electrical noise will cause a false lightning strike, but the more likely lightning strike events from far away will be filtered out and missed. A value between 0 to 15 can be used. Generally, a small deviation of one or two from the default value is sufficient to tune the level to the installation environment.

To set the Strike Reject Lvl follow the steps below:

1. Press **Enter** to begin changing the Strike Reject Lvl.
2. Press the **UP** and **DOWN** arrows to select the new level.
3. Press **Enter** or **SAVE** to save the new Strike Reject Lvl to the sensor.
4. Check the settings.
5. Follow the directions on the screen.
 - a. Change screens.
 - b. Recheck the saved settings.

3.10 BAROMETRIC SENSOR

The barometric pressure sensor is located behind the teflon screen next to the relative humidity sensor. It measures the atmospheric pressure of the environment in which the ATMOS 41 is deployed. With a range from 50 to 101 kPa, it is suitable for measurement across a wide range of elevations, but keep in mind that the magnitude of sensor output will depend chiefly on the installation altitude with subtle changes caused by weather.

3.11 TILT SENSOR

The ATMOS 41 is also equipped with a tilt sensor similar to those found in smartphones. Although this sensor may be used to level the instrument, it is much easier to use the small bubble level on the bottom of the anemometer plate. The primary use of the tilt sensor data will be to ensure the ATMOS 41 remains level at all times. Regularly check x and y tilt data to ensure the ATMOS 41 is level; if it has tilted, return to the site and level again. Even a few degrees off level can cause errors in the rain and solar radiation measurements.

3.12 THEORY

The following sections explain the theory of wind speed, wind direction, and air temperature measurements.

3.12.1 WIND SPEED AND DIRECTION

The theory behind the anemometer comes from Campbell and Unsworth (1979). The speed c (m/s) of sound in still air depends on air temperature T (K), vapor pressure e (kPa), and atmospheric pressure, p (kPa), as shown in [Equation 3](#).

$$c = 20.067 \sqrt{T \left(1 + \frac{0.32e}{P} \right)} \quad \text{Equation 3}$$

SYSTEM

For a given sound path length, d (m), the number of wavelengths, n , in still air is determined with [Equation 4](#).

$$n = \frac{vd}{c} \quad \text{Equation 4}$$

Here v is the frequency of the sound (Hz). When the air is moving, the sound speed is the sum of the wind speed and the speed of sound in still air. The anemometer transmits a sound pulse in a forward direction, then a similar pulse in the reverse direction. The difference in n between the two points is computed. If the vector magnitude of the wind in the direction of the sound is u (m/s), then

$$n - \Delta n_+ = \frac{vd}{c + u} \quad \text{Equation 5}$$

$$n - \Delta n_- = \frac{vd}{c - u} \quad \text{Equation 6}$$

for sound traveling with and against the wind. Subtracting the result of [Equation 5](#) from the results of [Equation 6](#) creates [Equation 7](#).

$$\Delta n = \Delta n_- + \Delta n_+ = \frac{2vdu}{c^2 - u^2} \quad \text{Equation 7}$$

Even at the maximum wind speeds for the anemometer, u^2 is only about 1% of c^2 , so the equation can be simplified as shown in [Equation 8](#).

$$x \cong \frac{c^2}{2vd} \Delta n \quad \text{Equation 8}$$

This is the basic equation for the anemometer. Delta (Δ) n is proportional to the phase difference between the forward and reverse sound pulses. The sound comes from a 40 kHz ultrasonic transducer in the head of the anemometer. A sound pulse is transmitted diagonally across the anemometer, bouncing off a sintered glass disk in the center. The sound pulse is then received by another transducer in the anemometer head that is opposite the first. Once the sound pulse is received, the receiver becomes the transmitter and the process is repeated. Two more sensors, mounted at 90 degrees from the first two, give the other horizontal component of the wind. The sound travels a total distance of about 72 mm from transmitter to receiver, but d in the equations is just the horizontal distance, which is 40 mm.

If u is the magnitude of the wind vector in the east-west direction (east +) and v is the magnitude in the north-south direction (north +), then wind speed is computed with [Equation 9](#).

$$S = \sqrt{\overline{u^2} + \overline{v^2}} \quad \text{Equation 9}$$

Where the overbar indicates an average of the values sampled every 10 seconds, wind speed is computed with [Equation 10](#).

$$\theta = \tan^{-1}(\overline{v}/\overline{u}) \quad \text{Equation 10}$$

The wind measurement requires 42 ms to complete. An additional 60 ms are required for the computations to determine phase differences. The anemometer samples every 10 s (or more often if requested). The gust speed reported is the highest instantaneous wind speed measured during the selected averaging interval (must be >20 s or gusts will equal speed).

NOTE: Cup anemometers average over a much longer interval than 42 ms, so the gusts measured with a sonic anemometer will have a larger peak-to-mean ratio than one would see with a cup anemometer.

3.12.2 TEMPERATURE SENSOR

The ATMOS 41 uses an energy balance correction to adjust measured temperature to actual air temperature according to [Equation 11](#)

$$T_{corr} = T_{uncorr} - \left(\frac{\alpha_s S_t}{c_p k \sqrt{\frac{u}{d}}} \right) \quad \text{Equation 11}$$

where:

α_s = the absorptivity of the surface to solar radiation

S_t = the total solar radiation measured

c_p = 29.3 J mol⁻¹ C⁻¹, k is a constant

u = the wind speed

d = the characteristic dimension

Although these values can be assumed, some (α_s and k) were optimized using a Levenberg Marquardt Least Squares analysis. Optimal air temperature was obtained using an Apogee TS-100 Aspirated Radiation Shield. Data were collected over several weeks and final values are shown in [Table 2](#).

NOTE: A maximum value optimization for S_t was added because radiation values higher than that cause the corrected temperature to deviate from actual values more than when a maximum S_t was used.

Table 2 Optimized values for air temperature correction

α_s	d (m)	k	c_p (J mol ⁻¹ K ⁻¹)	Max S_t (W/m ²)
0.295	0.00083	0.0984	29.3	352.3

SYSTEM

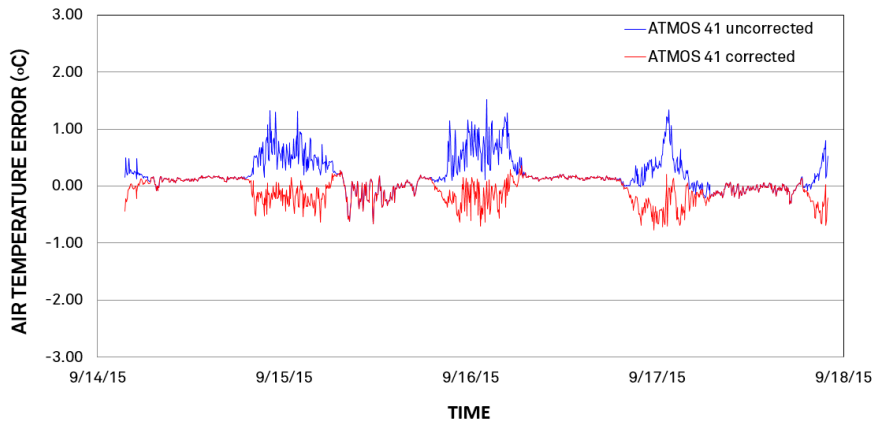

Figure 9 Corrected air temperature comparison with the aspirated radiation shield using 1-minute measurement intervals

Figure 9 shows the results from the temperature correction compared to the aspirated temperature, which shows data sampled at 1 min and not averaged over time. The estimated accuracy of the air temperature measurement, based on two standard deviations (95% confidence interval), is 0.42 °C. To provide an idea of how comparable the data are, a concurrently tested temperature sensor in a radiation shield (typical measurement approach) showed an accuracy of 0.66 °C, also based on a two-standard deviation estimate. Thus, the temperature correction of the ATMOS 41 appears to give a better estimate of actual air temperature than the generally accepted radiation shield technique.

NOTE: Without wind correction, the accuracy of the temperature measurement is ± 2 °C.

3.13 LIMITATIONS

The ATMOS 41 is engineered to be a robust device with minimal downtime. However, it does have limitations that will affect its measurements under some conditions.

3.13.1 SNOW AND ICE ACCUMULATION

The ATMOS 41 is not heated, so it will not measure frozen precipitation until snow and ice that have accumulated in the funnel melt. In locations with heavy snowfall and/or long periods below freezing, it is almost certain that snow accumulation will fill the funnel and no longer accumulate, leading to inaccurate precipitation measurements even when the precipitation melts. Accumulation of snow, ice, or frost will also adversely affect the accuracy of the solar radiation measurement and can compromise the wind measurements if accumulation occurs in the anemometer acoustic pathway or on the acoustic mirror (see [Section 2.2.1 on page 5](#)).

3.13.2 HEAVY RAIN AND STRONG WIND

During strong storm events, water can splash off of the horizontal bottom plate of the anemometer envelope and interrupt the signal passing between the sonic transducers. The spikes on the bottom plate help dissipate the energy of rainwater to minimize splashing and reduce the likelihood that the wind measurements are interrupted. Additionally, porous polyethylene membranes protect the ultrasonic transducers from direct splashing and the sintered (porous) glass construction draws water from the upper surface of the acoustic mirror to keep a constant sound path length. Despite these features heavy rain and strong wind can still cause water to reach the membranes and also cause temporary water buildup on the acoustic mirror. The hydrophobic nature of the transducer protective membranes and the quick-draining ability of the acoustic mirror should limit wind measurement interruptions to heavy rain events and should bring wind measurement back online soon after extreme conditions abate.

4. SERVICE

This section contains contact information, calibration frequencies, and troubleshooting guidelines.

4.1 CALIBRATION

Table 3 lists the recommended sensor calibration frequencies.

Table 3 Calibration Frequencies

Sensor Function	Calibration Frequency
Solar Radiation	Every 2 years ^a
Rain Gauge	Not needed
Lightning	Not needed
Wind	Not needed
Barometric Pressure	Every 1–2 years ^b
Relative Humidity (RH)	Every 1–2 years ^b
Compass	Not Needed

^a Contact Apogee Instruments for details on sending the pyranometer in for calibration: techsupport@apogeeinstruments.com +1.877.727.6433.

^b METER offers a service to calibrate barometric pressure and RH sensors (contact METER Support at support.environment@metergroup.com for more information).

4.2 CLEANING AND MAINTENANCE

1. Check the following areas to make sure they are clear of miscellaneous environmental, animal (specifically bird droppings), or insect debris:
 - a. Rain funnel
 - b. Solar radiation sensor
 - c. Anemometer opening
 - Do not remove the sensor from its mount to remove debris.
 - Be sure the sensor is still level after cleaning.
 - d. Sintered glass reflection plate
2. Clean the ATMOS 41
 - a. Scrub with light to medium pressure using a warm, damp cloth.
 - b. Completely dry the sensor by removing excess water using a dry cloth.

SERVICE

c. Clean around posts and between crevices using a dry brush.

DO NOT immerse the sensor in water.

DO NOT touch the temperature sensor needle (Figure 10).

Avoid more than light pressure on the sonic transducers (Figure 10).

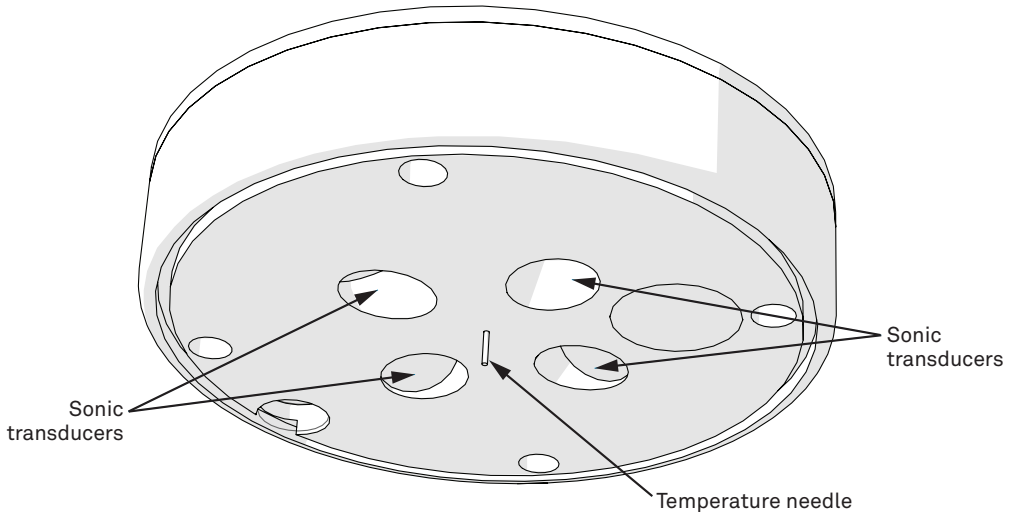

Figure 10 Temperature needle and sonic transducers

NOTE: Do not allow water to enter the ultrasonic sensors (Figure 10). Water may corrode the metal parts inside the sensors and ruin them. Do not touch the temperature sensor when cleaning because it is very delicate and can be damaged if pushed into the ATMOS 41 body.

3. Make sure nothing is obscuring the temperature sensor or the sonic transducers shown in Figure 10 (cobwebs, leaves, wasp nests, etc.).
4. Check the downspout (Figure 11) for debris.
5. Observe the Teflon screen (Figure 12) to see if it is dirty.
If the screen is dirty, it is best to replace it.

Contact METER support at support.environment@metergroup.com for a replacement.

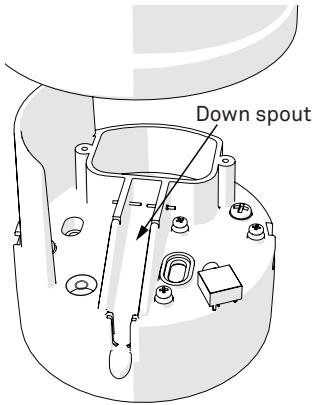

Figure 11 Down spout

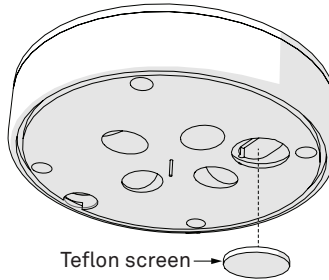

Figure 12 Teflon screen

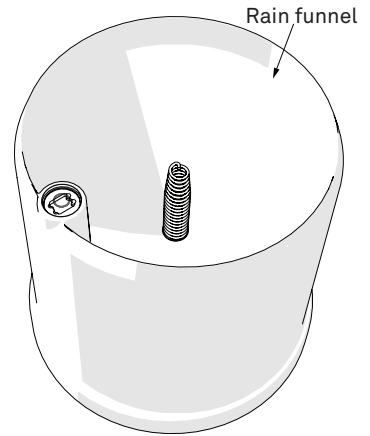

Figure 13 Rain funnel

4.3 TROUBLESHOOTING

Table 4 Troubleshooting the ATMOS 41

Problem	Possible Solutions
ATMOS 41 not responding	<p>Check power to the sensor.</p> <p>Check sensor cable and 3.5-mm plug integrity.</p> <p>Check data logger wiring to ensure the following connections:</p> <ul style="list-style-type: none"> • Brown—3.6 V to 15 V power supply • Orange—digital out • Bare—ground <p>If sensor does not respond, use the ProCheck to make sure it is working satisfactorily.</p>

Table 4 Troubleshooting the ATMOS 41 (continued)

Problem	Possible Solutions
<p>Not reading any rain</p>	<p>Check and remove any debris from rain gauge funnel. The ATMOS 41 must be within approximately ± 2 degrees of dead level in both the X and Y directions to accurately measure rainfall. If not within this range, drops from the flared hole can miss the gold electrodes entirely. Use the internal level measurements that are available in the ATMOS 41 data stream to confirm that the ATMOS 41 is level.</p> <p>Gently twist the top of the weather station and remove the rain gauge funnel.</p> <p>BE CAREFUL TO UNPLUG THE PYRANOMETER CONNECTOR INSIDE THE FUNNEL BEFORE REMOVING THE FUNNEL COMPLETELY.</p> <p>Check to make sure that there are no obvious problems and that the gold electrodes are aligned correctly Figure 15.</p> <div style="display: flex; justify-content: space-around; align-items: flex-start;"> <div style="text-align: center;">  <p>Figure 14 Pyranometer</p> </div> <div style="text-align: center;">  <p>Figure 15 Gold electrodes</p> </div> </div>
<p>Water not flowing through rain gauge</p>	<p>Check all screens and the outflow to ensure there is no lodged debris.</p>
<p>No wind speed</p>	<p>Check anemometer pathway to make sure there is no debris blocking the path of the sonic transducer measurement (between transducers and polished metal on base).</p> <p>Check the sonic transducers to make sure that there is no water build-up; if there is moisture, take a dry cloth and dab it away.</p> <p>Check to see that the acoustic mirror Figure 4 is not dirty. Clean by flushing with water and dry with a dry cloth (see Section 4.2 on page 25).</p> <p>Be sure the ATMOS 41 is level.</p>
<p>No temperature reading</p>	<p>Check the temperature needle to be sure it is not pushed in (pushing in the temperature sensor will break the thermistor wires and stop measurement).</p> <p>Try not to abuse the temperature needle when cleaning, as its very delicate lead wires can be damaged.</p>

Table 4 Troubleshooting the ATMOS 41 (continued)

Problem	Possible Solutions
No pyranometer reading	Carefully remove the rain funnel as described in Section 3.5 on page 15 . BE CAREFUL TO UNPLUG THE PYRANOMETER CONNECTOR INSIDE THE FUNNEL BEFORE FULLY REMOVING THE FUNNEL. Make sure the pyranometer plug (Figure 14) is plugged in.

4.4 CUSTOMER SUPPORT

Customer service representatives are available for questions, problems, or feedback Monday through Friday, 8 am–5 pm Pacific time.

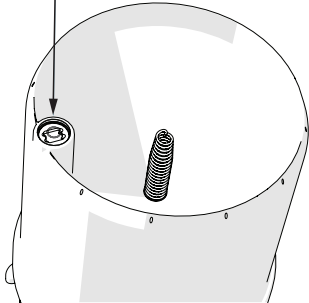
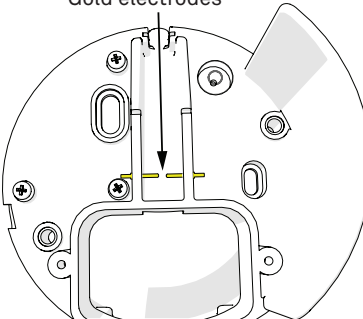
Email: support.environment@metergroup.com
sales.environment@metergroup.com

Phone: +1.509.332.5600

Fax: +1.509.332.5158

Website: www.metergroup.com

If contacting METER by email or fax, please include the following information:

<i>Name</i>	<i>Fax number</i>
<i>Address</i>	<i>Instrument serial number</i>
<i>Phone</i>	<i>Description of the problem</i>

NOTE: For ATMOS 41 weather stations purchased through a distributor, please contact the distributor directly for assistance.

4.5 TERMS AND CONDITIONS

CONTRACT FORMATION. All requests for goods and/or services by METER Group, Inc. USA (METER) are subject to the customer's acceptance of these Terms and Conditions. The Buyer will be deemed to have irrevocably accepted these Terms and Conditions of Sale upon the first to occur of the Buyer's issuance of a purchase order or request for goods or services. Unless expressly assented to in writing by METER, terms and conditions different are expressly rejected. No course of dealing between the parties hereto shall be deemed to affect or to modify, amend, or discharge any provisions of this agreement.

PRICES AND PAYMENT. Invoice prices will be based upon METER prices as quoted or at METER list price in effect at the time an order is received by the Seller. Prices do not include any state or federal taxes, duties, fees, or charges now or hereafter enacted applicable to the goods or to this transaction, all of which are the responsibility of the Buyer. Unless otherwise specified on the invoice, all accounts are due and payable 30 days from the date of invoice. Unpaid accounts extending beyond 30 days will be subject to a service charge of 2% per month (24% per annum). Should Seller initiate any legal action or proceeding to collect on any unpaid invoice, Seller shall be entitled to recover from Buyer all costs and expenses incurred in connection therewith, including court costs and reasonable attorney's fees.

RISK OF LOSS AND DELIVERY TITLE. Liability for loss or damage passes to the Buyer when the Seller delivers the goods on the Seller's dock or to the transporting agent, whichever occurs first. The Seller has the right to deliver the goods in installments. Shipping and delivery dates communicated by the Seller to the Buyer are approximate only.

SHIPMENT. In the absence of specific shipping instructions, the Seller, if and as requested by the Buyer, will ship the goods by the method the Seller deems most advantageous. Where the Seller ships the goods, the Buyer will pay all transportation charges that are payable on delivery or, if transportation charges are prepaid by the Seller, the Buyer will reimburse the Seller upon receipt of an invoice from the Seller. The Buyer is obligated to obtain insurance against damage to the goods being shipped. Unless otherwise specified, the goods will be shipped in the standard Seller commercial packaging. When special packing is required or, in the opinion of the Seller, required under the circumstances, the cost of the special packaging shall be the responsibility of the Buyer.

INSPECTION AND ACCEPTANCE. Goods will be conclusively deemed accepted by the Buyer unless a written notice setting out reasonable particulars of the rejected goods and the reason for the rejection is sent by the Buyer to the Seller within 10 days of delivery of the goods. The Buyer will place rejected goods in safe storage at a reasonably accessible location for inspection by the Seller.

CUSTOM GOODS. There is no refund or return for custom or nonstandard goods.

WARRANTIES. The Seller warrants all equipment manufactured by it to be free from defects in parts and labor for a period of one year from the date of shipment from factory. The liability of the Seller applies solely to repairing, replacing, or issuing credit (at the Seller's sole discretion) for any equipment manufactured by the Seller and returned by the Buyer during the warranty period. SELLER MAKES NO SEPARATE OR OTHER WARRANTY OF ANY NATURE WHATSOEVER, EXPRESS OR IMPLIED, INCLUDING THE WARRANTY OF MERCHANTABILITY OR FOR A PARTICULAR PURPOSE. There shall be no other obligations either expressed or implied.

LIMITATION OF LIABILITY. Seller will not be liable to the Buyer or any other person or entity for indirect special, incidental, consequential, punitive, or exemplary damages in connection with this transaction or any acts or omissions associated therewith or relating to the sale or use of any goods, whether such claim is based on breach of warranty, contract, tort, or other legal theory and regardless of the causes of such loss or damages or whether any other remedy provided herein fails. In no event will the Seller's total liability under this contract exceed an amount equal to the total amount paid for the goods purchased hereunder.

WAIVER. In the event of any default under or breach of the contract by the Buyer, the Seller has the right to refuse to make further shipments. The Seller's failure to enforce at any time or for any period of time the provisions of this contract will not constitute a waiver of such provisions or the right of the Seller to enforce each and every provision.

GOVERNING LAW. The validity, construction, and performance of the contract and the transactions to which it relates will be governed by the laws of the United States of America. All actions, claims, or legal proceedings in any way pertaining to this contract will be commenced and maintained in the courts of Whitman County, State of Washington, and the parties hereto each agree to submit themselves to the jurisdiction of such court.

SEVERABILITY. If any of the Terms and Conditions set out in this contract are declared to be invalid by a court, agency, commission, or other entity having jurisdiction over the interpretation and enforcement of this contract, the applications of such provisions to parties or circumstances other than those as to which it is held invalid or unenforceable will not be affected. Each term not so declared invalid or unenforceable will be valid and enforced to the fullest extent permitted by law and the rights and obligations of the parties will be construed and enforced as though a valid commercially reasonable term consistent with the undertaking of the parties under the order has been substituted in place of the invalid provision.

SET-OFF. The Buyer may not set-off any amount owing from the Seller to the Buyer against any amount payable by the Buyer to the Seller whether or not related to this contract.

REFERENCES

Campbell, G.S. and M.H. Unsworth (1979) *An inexpensive sonic anemometer for eddy correlation*. J. Appl. Meteor. 18:1072–1077.

Buck, A.L. (1981) *New equations for computing vapor pressure and enhancement factor*. J. Appl. Meteor. 20:1527–1432.

INDEX

- A**
- Applications 1
- C**
- Calibration and configuration 18
 - Configuring the compass 18
 - Lightning strike reject
 - level configuration 18
 - Sensor calibration scheduler 25
- Cleaning 25
- Components 20
- Connecting the ATMOS 41 5
- Connecting to non-METER logger 6
- Connections 5
- Customer support 29
- D**
- Data acquisition system 4
 - See also Installation, Connecting the ATMOS 41
- I**
- Installation 3
 - Connecting the ATMOS 41 5–7
 - Mounting 4
 - Tools required 3
- L**
- Limitations 23
- M**
- Maintenance 25
 - Rain gauge 15
- Measurements 1, 9–11
 - Air temperature 1, 9, 16
 - Barometric pressure 1, 10, 19
 - Compass orientation 1, 10, 17
 - Humidity sensor temperature 9
 - Lightning distance 1, 11
 - Lightning strikes 1, 10
 - Precipitation 1, 9
 - Precipitation max intensity 1, 9
 - Relative humidity 1, 9
 - Solar radiation 1, 9, 12
 - Tilt 1, 10, 19
 - Vapor pressure 1, 9, 14
 - Wind direction 1, 10, 13
 - Wind gust 1, 10, 13
 - Wind speed 1, 10, 13
- R**
- References 31
- S**
- Sensors
 - Anemometer 13
 - Barometric pressure 19
 - Compass 17
 - Lightning sensor 17
 - Pyranometer 12
 - Rain gauge 15
 - Temperature sensor 16
 - Tilt 19
 - Vapor pressure sensor 14
- Settings 19
- Specifications 9–12
 - Cable length 11
 - Compliance 12
 - Dimensions 11
 - Electrical and timing characteristics 11
 - Measurement specifications 9
- T**
- Terms and conditions 30
- Theory
 - Air temperature 16–17, 21–22
 - Lightning distance 17
 - Lightning strikes 17
 - Precipitation 15–16
 - Precipitation max intensity 15–16
 - Relative humidity 14
 - Solar radiation 12
 - Temperature sensor 16
 - Vapor pressure 14

INDEX

- Wind direction 13, 19–21
- Wind gust 13
- Wind speed 13, 19–21
- Troubleshooting
 - ATMOS 41 not responding 27
 - No pyranometer reading 29
 - No temperature reading 28
 - Not reading any rain 28
 - No wind speed 28
 - Precipitation measurements in
 - frozen conditions 23
 - Water not flowing through rain gauge 28
 - Wind speed and direction errors during
 - heavy rain and strong wind 23

Z

ZENTRA

- ZENTRA Cloud 6
- ZENTRA Utility 6

METER Group
2365 NE Hopkins Court
Pullman, WA 99163
T: +1.509-332-5601 F: +1.509.332.5158
E: support@metergroup.com
W: www.metergroup.com

